

## IMPORTANT SAFETY INSTRUCTIONS

### CALIFORNIA PROPOSITION 65

WARNING: This product contains chemical known to the state of California to cause cancer or reproductive toxicity.

1. **SAVE THESE INSTRUCTIONS**
  - This manual contains important safety and operating instructions for battery charger model PRO25S/PRO25SE (1094).
2. Do not expose charger to rain or snow.
3. Use of an attachment not recommended or sold by CTEK may result in a risk of fire, electric shock or injury to persons.
4. To reduce risk of damage to electric plug and cord, pull by the plug rather than cord when disconnecting charger.
5. An extension cord should not be used unless absolutely necessary. Use of improper extension cord could result in a risk of fire and electric shock. If an extension cord must be used, make sure that: a) Pins on plug of extension cord are the same number, size and shape as those of plug on charger; b) Extension cord is properly wired and in good electrical condition; and c) Wire size is large

enough for AC ampere rating of charger as specified in "RECOMMENDED MINIMUM AWG SIZE FOR AC EXTENSION CORDS".

6. Do not operate charger with damaged cord or plug - return the charger to the retailer.
7. Do not operate charger if it has received a sharp blow, been dropped or otherwise damaged in any way; take it to the retailer.
8. Do not disassemble charger; take it to the retailer when service or repair is required. Incorrect reassembly may result in a risk of electrical shock or fire.
9. To reduce risk of electric shock, unplug charger from AC outlet before attempting any maintenance or cleaning.

10. **WARNING - RISK OF EXPLOSIVE GASES**
  - a) **WORKING IN VICINITY OF A LEAD-ACID BATTERY IS DANGEROUS. BATTERIES GENERATE EXPLOSIVE GASES DURING NORMAL BATTERY**

# OPERATION. FOR THIS REASON, IT IS OF OUTMOST IMPORTANCE THAT YOU FOLLOW THE INSTRUCTIONS EACH TIME YOU USE THE CHARGER.

- b) To reduce risk of battery explosion, follow these instructions and those published by the battery manufacturer and the manufacturer of any equipment you intend to use in vicinity of battery. Review cautionary marking on these products and on engine.

## 11. PERSONAL PRECAUTIONS

- a) Consider having someone close enough by to come to your aid when you work near a lead-acid battery.
- b) Have plenty of fresh water and soap nearby in case battery acid contacts skin, clothing or eyes.
- c) Wear complete eye protection and clothing protection. Avoid touching eyes while working near battery.
- d) If battery acid contacts skin or clothing, wash immediately with soap and water. If acid enters eye, immediately flood eye with running cold water for at least 10 minutes and get medical attention immediately.

- e) NEVER smoke or allow a spark or flame in vicinity of battery or engine.
- f) Be extra cautious to reduce risk of dropping a metal tool onto battery. It might spark or short-circuit battery or other electrical part that may cause explosion.
- g) Remove personal metal items such as rings, bracelets, necklaces, and watches when working with lead-acid battery. A lead-acid battery can produce a short-circuit current high enough to weld a ring or the like to metal, causing a severe burn.
- h) Use charger for charging a LEAD-ACID battery only. It is not intended to supply power to a low voltage electrical system other than in a starter-motor application. Do not use battery charger for charging dry-cell batteries that are commonly used with home appliances. These batteries may burst and cause injury to persons and damage to property.
- i) NEVER charge a frozen battery.

## 12. PREPARING TO CHARGE

- a) If necessary to remove battery from vehicle to charge, always remove grounded terminal from battery first. Make sure all accessories in the vehicle are off, so as not to cause an arc.
- b) Be sure area around battery is well ventilated while battery is being charged.
- c) Clean battery terminals. Be careful to keep corrosion from coming in contact with eyes.

- d) Add distilled water in each cell until battery acid reaches level specified by battery manufacturer. Do not overfill. For a battery without removable cell caps, such as valve regulated lead acid batteries, carefully follow manufacturer's recharging instruction.
- e) Study all battery manufacturer's specific precautions while charging and recommended rates of charge.
- f) Determine voltage of battery by referring to car owner's manual and make sure it matches output rating of battery charger.

### 13. CHARGER LOCATION

- a) Locate charger as far away from battery as DC cables permit.
- b) Never place charger directly above battery being charged; gases from battery will corrode and damage charger.
- c) Never allow battery acid to drip on charger when reading electrolyte specific gravity or filling battery.
- d) Do not operate charger in a closed-in area or restrict ventilation in any way.
- e) Do not set a battery on top of charger.

### 14. DC CONNECTION PRECAUTIONS

- a) Connect and disconnect dc output clips only after setting any charger switches to "off" position and removing AC cord from electric outlet. Never allow clips to touch each other.
- b) Attach clips to battery and chassis as indicated in 15(e), 15(f), 16(b) through 16(d).

### 15. FOLLOW THESE STEPS WHEN BATTERY IS INSTALLED IN VEHICLE. A SPARK NEAR BATTERY MAY CAUSE BATTERY EXPLOSION. TO REDUCE RISK OF A SPARK NEAR BATTERY:

- a) Position AC and DC cords to reduce risk of damage by hood, door or moving engine part.
- b) Stay clear of fan blades, belts, pulleys, and other parts that can cause injury to persons.
- c) Check polarity of battery posts. POSITIVE (POS, P, +) battery post usually has larger diameter than NEGATIVE (NEG, N, -) post.

- d) Determine which post of battery is grounded (connected) to the chassis. If negative post is grounded to the chassis (as in most vehicles) see (e). If positive post is grounded to the chassis, see (f).
- e) For Negative-grounded vehicle, connect POSITIVE (RED) clip from battery charger to POSITIVE (POS, P, +) ungrounded post of battery. Connect NEGATIVE (BLACK) clip to vehicle chassis or engine block away from battery. Do not connect clip to carburetor, fuel lines, or sheet-metal body parts. Connect to a heavy gage metal part of the frame or engine block.
- f) For Positive-grounded vehicle, connect NEGATIVE (BLACK) clip from battery charger to NEGATIVE (NEG, N, -) ungrounded post of battery. Connect POSITIVE (RED) clip to vehicle chassis or engine block away from battery. Do not connect clip to carburetor, fuel lines, or sheet-metal body parts. Connect to a heavy gage metal part of the frame or engine block.
- g) When disconnecting charger, turn switches to off, disconnect AC cord, remove clip from vehicle chassis, and then remove clip from battery terminal.
- h) See operating instructions for length of charge information.

## 16. FOLLOW THESE STEPS WHEN BATTERY IS OUTSIDE VEHICLE. A SPARK NEAR BATTERY MAY

## CAUSE BATTERY EXPLOSION. TO REDUCE RISK OF A SPARK NEAR BATTERY:

- a) Check polarity of battery terminals. POSITIVE (POS, P, +) battery post usually has a larger diameter than NEGATIVE (NEG, N, -) post.
- b) Connect POSITIVE (RED) charger clip to POSITIVE (POS, P, +) post of battery.
- c) Position yourself and free end of cable as far away from battery as possible - then connect NEGATIVE (BLACK) charger clip to NEGATIVE (NEG, N, -) post of battery.
- d) Do not face battery when making the final connection.
- e) When disconnecting charger, always do so in reverse sequence of connecting procedure and break first connection while as far away from battery as practical.
- f) A marine (boat) battery must be removed and charged on shore. To charge it on board requires equipment specially designed for marine use.

## IMPORTANT SAFETY INFORMATION!

- Charge no other batteries than specified in TECHNICAL INFORMATION.
- Check the charger cables prior to use. Ensure that no cracks have occurred in the cables or in the bend protec-

tion. A charger with damaged cables must be returned to the retailer.

- Ensure that the cabling does not jam or comes into contact with hot surfaces or sharp edges.
- Never charge a damaged battery.
- Never place the charger on top of the battery when charging.
- Avoid covering the charger.
- All batteries fail sooner or later. A battery that fails during charging is normally taken care of by the chargers advanced control, but some rare errors in the battery could still exist. Don't leave any battery during charging unattended for a longer period of time.
- If power consumers like fitted alarms and navigation computers are connected to the battery, the charging process takes longer and may drain the battery.
- Always check that the charger has switched to STEP 7 before leaving the charger unattended and connected for long periods. If the charger has not switched to STEP 7 within 50 hours, this is an indication of an error. Disconnect the charger.
- Batteries consume water during use and charging. For batteries where water can be added, the water level should be checked regularly. If the water level is low add distilled water.
- This appliance is not designed for use by young children or people who cannot read or understand the manual unless they are under the supervision of a responsible person to

ensure that they can use the battery charger safely. Store and use the battery charger out of the reach of children, and ensure that children cannot play with the charger.

- Connection to the mains supply must be in accordance with the national regulations for electrical installations.
- Do not extend the charge cable.
- For safe use place the charger with the bottom down when installing and charging.

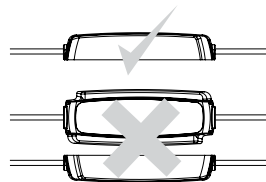

# RECOMMENDED MINIMUM AWG SIZE FOR AC EXTENSION CORDS

LENGTH OF CORD FEET (M)	AWG SIZE OF CORD
25 (7.6)	18
50 (15.2)	18
100 (30.5)	18
150 (45.6)	16

# CONNECT AND DISCONNECT THE CHARGER TO A BATTERY

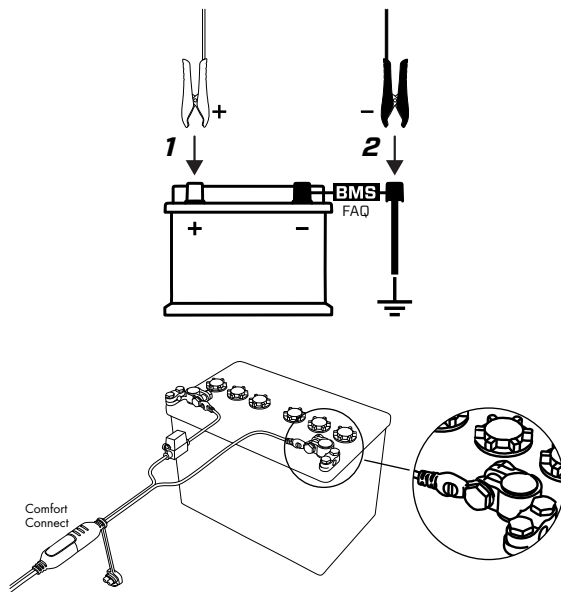

# OPERATING INSTRUCTIONS

1. Connect the charger to the battery.

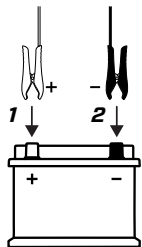

## For batteries mounted inside a vehicle



1. Connect the charger according to the vehicle's manual.
2. Connect the charger to the wall socket.
3. Disconnect the charger from the wall socket before disconnecting the battery.
4. Disconnect the black clamp before the red clamp.

2. Connect the charger to the wall socket. The power lamp will indicate that the mains cable is connected to the wall socket. The error lamp will indicate if the battery clamps are incorrectly connected. The reverse polarity protection will ensure that the battery or charger will not be damaged.
3. Press the MODE-button to select charging program.
4. Follow the indication lamps through the charging process. The battery is ready to start the engine when is lit. The battery is fully charged when is lit.
5. Stop charging at any time by disconnecting the mains cable from the wall socket.

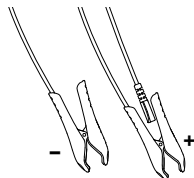

## Temperature sensor

The temperature sensor works automatically and will adjust the voltage to the ambient temperature. Place the temperature sensor in the positive clamp or as close to the battery as possible.

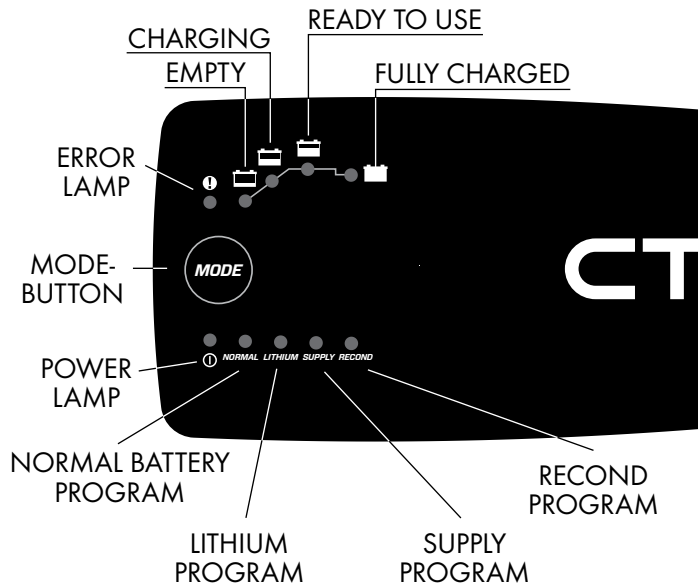

# CHARGING PROGRAMS

Settings are made by pressing the MODE-button. After about two seconds the charger activates the selected program. The selected program will be restarted next time the charger is connected.

**The table explains the different Charging Programs:**

Program	Explanation
<b>NORMAL</b>	<b>Normal battery program</b> 14.4V/25A. Only for lead-acid batteries.
<b>RECOND</b>	<b>Recond program</b> 15.8V/1.5A Use Recond to return energy to empty WET and Ca/Ca batteries. Recond your battery once per year and after deep discharge to maximize lifetime and capacity. The Recond program adds the Recond step to the normal battery program. Only for lead-acid batteries.
<b>SUPPLY</b>	<b>Supply program</b> 13.6V/25A Use as a 12V power supply or use for float maintenance charging when 100% capacity of the battery is required. The Supply program activates the Float step without time or voltage limitation. ⚠ The spark protection on the battery charger is disabled during the SUPPLY program.



## READY TO USE

The table shows the estimated time to charge a battery from empty to 80%

BATTERY SIZE (Ah)	TIME TO 80% CHARGED
40Ah	1.5h
100Ah	3h
200Ah	6h
300Ah	16h

## POWER LAMP

If the power lamp is lit with a:



### 1. STEADY LIGHT

The mains cable is connected to the wall socket.

### 2. FLASHING LIGHT:

The charger has entered the energy save mode. This happens if the charger isn't connected to the battery within 2 minutes or the battery voltage is below 2V.

## ERROR LAMP

If the error lamp is lit, check the following:



**1. Is the charger's red clamp connected to the battery's positive pole? Connect the charger according to the vehicle's manual.**

**2. Is the charger connected to a 12V battery?**

**3. Are the clamps short circuited?**

**4. Has charging been interrupted in  or ?**





Restart the charger by pressing the MODE-button. If charging is still being interrupted, the battery...

 ...is seriously sulphated and may need to be replaced.

 ...can not accept charge and may need to be replaced.

 ...can not keep charge and may need to be replaced.

## LEAD-ACID

								
	1	2	3	4	5	6	7	8
<b>NORMAL</b>	15.8V	Max 25A until 12.6V	Increasing voltage to 14.4V, max 25A	Declining current 14.4V	Checks if voltage drops to 12V		13.0V*, 13.6V max 25A	12.9V-14.4V 20-1.2A
<b>RECOND</b>	15.8V	Max 25A until 12.6V	Increasing voltage to 14.4V, max 25A	Declining current 14.4V	Checks if voltage drops to 12V	Max 15.8V Max 1.5A	13.0V*, 13.6V max 25A	12.9V-14.4V 20-1.2A
Time limit:	8h		20h	16h	3 minutes	2h or 6h	10 days (*first day) charge cycle restarts if voltage drops	Charge cycle restarts if voltage drops or 24h time passed

### STEP 1 DESULPHATION

Detects sulphated batteries. Pulsing current and voltage, removes sulphate from the lead plates of the battery restoring the battery capacity.

### STEP 2 SOFT START

Tests if the battery can accept charge. This step prevents that charging proceeds with a defect battery.

### STEP 3 BULK

Charging with maximum current until approximately 80% battery capacity.

### STEP 4 ABSORPTION

Charging with declining current to maximize up to 100% battery capacity.

### STEP 5 ANALYZE

Tests if the battery can hold charge. Batteries that can not hold charge may need to be replaced.

### STEP 6 RECOND

Choose the Recond program to add the Recond step to the charging process. During the Recond step voltage increases to create controlled gassing in the battery. Gassing mixes the battery acid and gives back energy to the battery.

### STEP 7 FLOAT

Maintaining the battery voltage at maximum level by providing a constant voltage charge.

### STEP 8 PULSE

Maintaining the battery at 95-100% capacity. The charger monitors the battery voltage and gives a pulse when necessary to keep the battery fully charged.

# CHARGING PROGRAMS



Settings are made by pressing the MODE-button. After about two seconds the charger activates the selected program. The selected program will be restarted next time the charger is connected.

**The table explains the different Charging Programs:**



Program	Explanation
<i>LITHIUM</i>	<p><b>Lithium* program</b> 13.8V/25A Use for LITHIUM* batteries.</p>
<i>SUPPLY</i>	<p><b>Supply program</b> 13.6V/25A Use as a 12V power supply or use for float maintenance charging when 100% capacity of the battery is required. The Supply program activates the Float step without time or voltage limitation. ⚠ The spark protection on the battery charger is disabled during the SUPPLY program.</p>

\*) 12V lithium batteries (LiFePO<sub>4</sub>, Li-Fe, Li-iron, LFP)

## BATTERIES WITH "UNDER VOLTAGE PROTECTION"

Some Lithium\* batteries have an on-board UVP (under voltage protection) that disconnects the battery to avoid it becoming too deeply discharged. This prohibits the charger from detecting that there's a battery connected. To bypass this, the battery charger needs to open the UVP. There are two options available to "wake up" the battery - automatic and manual. During the automatic "wake up" period the LED  will flash until the charge program is started and LED  is lit with a steady light. Automatic "wake up" will be active for maximum 5 minutes.

If the charger is in Standby mode after 10 minutes ( power led is flashing) the automatic wake up did not succeed. Try the manual wake up.

To use the manual "wake up", press the Mode button for approximately 10 seconds to bypass the UVP. During the "wake up" period the LED  will flash until the charge program is started and the LED  is lit with a steady light. If the manual wake up is unsuccessful the power LED  will start to flash after latest 10 minutes. Disconnect any parallel loads from the battery and try again. If the charging does not start after that, the battery may need to be replaced.

## POWER LAMP

If the power lamp is lit with a:

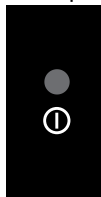

### 1. STEADY LIGHT

The mains cable is connected to the wall socket.

### 2. FLASHING LIGHT:

The charger has entered the energy save mode. This happens if the charger isn't connected to the battery within 2 minutes.

## ERROR LAMP

If the error lamp is lit, check the following:



**1. Is the chargers red clamp connected to the battery's positive pole? Connect the charger according to the vehicles manual.**

**2. Is the charger connected to a 12V battery?**

**3. Are the clamps short circuited?**

**4. Has charging been interrupted in  or ?**

Restart the charger by pressing the MODE-button. If charging is still being interrupted, the battery...

 ...can not accept charge or paralell loads may be connected to the battery. Remove the paralell loads and restart the charging by pressing the MODE-button.

...restart the charger maximum 3 times. If the charger doesn't continue to Bulk after that, the battery may need to be replaced.





 ...can not keep charge and may need to be replaced.

## READY TO USE

The table shows the estimated time to charge a battery from empty to 80%

BATTERY SIZE (Ah)	TIME TO 80% CHARGED
40Ah	1.5h
100Ah	3h
200Ah	6h
300Ah	16h

\*) 12V lithium batteries (LiFePO<sub>4</sub>, Li-Fe, Li-iron, LFP)

								
Wake up	1	2	3	4	5	6	7	8
LITHIUM 13.0V	Max 25A		Max 25A until 13.8V	Declining current 13.8V	Checks if voltage drops to 12.0V	14.4V	13.3V Max 25A	13.0V-13.8V 2.5A-3.0A
Time limit:	Max 10 minutes		Max 30h	Max 4h	3 minutes	If start charge voltage less than 13.9V then max 2h	10 days Charge cycle restarts if voltage drops	Max 1h pulse Auto pulse 10 days

**STEP 1-2 ACCEPT**

Tests if the battery can accept charge. This step prevents that charging proceeds with a defect battery.

**STEP 3 BULK**

Charging with maximum current until approximately 90% battery capacity.

**STEP 4 ABSORPTION**

Charging with declining current to maximize up to 95% battery capacity.

**STEP 5 ANALYZE**

Tests if the battery can hold charge. Batteries that can not hold charge may need to be replaced.

**STEP 6 COMPLETION**

Final charge with reduced current.

**STEP 7 FLOAT**

Maintaining the battery voltage at maximum level by providing a constant voltage charge.

**STEP 8 PULSE**

Maintaining the battery at 95-100% capacity. The charger monitors the battery voltage and gives a pulse when necessary to keep the battery fully charged.

# TECHNICAL SPECIFICATIONS

Model number	1094
INPUT	100-120VAC, 50-60Hz, 6.0A
OUTPUT	25A, 12V
Start voltage	2.0V Lead Acid batteries 8.0V Lithium batteries
Back current drain*	Less than 2.3Ah/month
Ripple**	Less than 4%
Ambient temperature	-4°F to +122°F (-20°C to +50°C)
Battery types	12V: WET, EFB, MF, Ca/Ca, AGM, GEL, LiFePO <sub>4</sub>
Battery capacity	40-500Ah, Lead Acid battery types 30-450Ah, Lithium battery types
CEC-400 Battery capacity	150-400Ah
Warranty	2 years

\* ) Back current drain is the current that drains the battery if the charger is not connected to the mains. CTEK chargers have a very low back current.

\*\* ) The quality of the charging voltage and charging current is very important. A high current ripple heats up the battery which has an aging effect on the positive electrode. High voltage ripple could harm other equipment that is connected to the battery. CTEK battery chargers produce very clean voltage and current with low ripple.

## LIMITED WARRANTY

CTEK Power Inc., issues this limited warranty to the original purchaser of this product. This limited warranty is not transferable. The warranty applies to manufacturing faults and material defects. The customer must return the product for inspection together with the receipt of purchase to the retailer. CTEK Power Inc. will, in its sole discretion, either (i) return the product to customer if it is not determined to be defective, or (ii) without regard to whether or not the original product is determined to be defective, either (A) provide customer with a new replacement product of the same or comparable model to customer, or (B) provide customer with a full refund for the product purchase price. This warranty is void if the battery charger has been opened, handled carelessly or repaired by anyone other than CTEK Power Inc. or its authorized representatives. THE FOREGOING WARRANTY, RIGHTS AND REMEDIES ARE EXCLUSIVE AND IN LIEU OF ALL OTHER WARRANTIES, RIGHTS OR REMEDIES, EXPRESS OR IMPLIED, WHICH MAY OTHERWISE BE AVAILABLE; ALL OTHER WARRANTIES, INCLUDING BUT NOT LIMITED TO, ANY WARRANTY OF MERCHANTABILITY OR FITNESS FOR A PARTICULAR PURPOSE, ARE HEREBY EXPRESSLY DISCLAIMED, EXCLUDED AND WAIVED BY CUSTOMER TO THE FULLEST EXTENT PERMITTED BY LAW. UNDER NO CIRCUMSTANCES SHALL CTEK POWER INC. OR ANY AFFILIATED PARTY THEREOF BE LIABLE FOR ANY INDIRECT, INCIDENTAL, PUNITIVE OR CONSEQUENTIAL DAMAGES OF ANY KIND.

## MAINTENANCE INSTRUCTIONS

The PRO25S/PRO25SE (1094) is maintenance-free. The charger must not be opened; doing so will invalidate the warranty. If the power cable is damaged the charger must be returned to the retailer. The charger casing can be cleaned using a damp cloth and mild cleaning agent. Remove the plug from the power socket before cleaning.

## SUPPORT

For support, FAQ, latest revised manual and more information about CTEK products: [www.ctek.com](http://www.ctek.com)